

Expanding your opportunities



eikon[®] e1s



User Manual CE

Section 2: Operations and Installation Guide



Table of Contents

Document information	4
Version control	4
Document purpose	4
Related documents	4
How to use this guide	4
Symbols and their meanings	4
2A. Introduction to e1s	5
Identifying your microwave combination oven	5
Appliance parts and their functions	6
Equipment and accessories supplied	7
2B. Installing the appliance	8
Unpacking	8
Taking the appliance off the pallet	8
Installation location requirements	9
Electrical installation requirements	10
Safety rules	10
Equipment provided by customer and electrical installation regulations	10
The requirements and specifications for e1s	10
2C. Getting started	12
Fitting the air filter	12
Inserting the cook plate	12
Turning the oven on and off	12
Settings on first usage	13
Selecting suitable utensils	14
Preheating the oven	14
Understanding the main menu and keyboard	15
2D. Cooking procedures	16
How to cook	16
Using a cooking profile – quick serve mode	17
Using a cooking profile – full serve mode	18
Choosing cooking profiles for Press&Go menu	19
Running a cooking profile from the Press&Go menu	19
Changing the cavity temperature	20
2E. Cooking profiles	21
Creating a cooking profile	21



Viewing and editing cooking profiles.....	22
Moving a cooking profile in a group of cooking profiles.....	22
Moving a cooking profile in a list	23
Adding a new cooking profile group.....	23
Adding a cooking profile to a group of cooking profiles	24
Deleting a cooking profile group.....	24
Editing a selected cooking profile group name.....	25
2F. Changing settings	26
Changing settings process	26
Operating mode / navigation settings.....	27
Language settings.....	27
Cavity temperature settings and labels	28
Service information and error logs.....	29
Cooking profile counters.....	29
Setting the date and time	30
Sound settings.....	31
Temperature timer setting	32
USB programme downloads	33
Temperature band setting.....	34
Change setting / service access password.....	34
Set screen saver	35
2G. Cool-down procedures	36
2H. Cleaning procedures.....	37
Daily cleaning tasks	37
Cleaning items	37
Cleaning instructions.....	38
Pre-cleaning checklist.....	38
Cleaning process.....	38
2I. End of day operations	42
Turning the oven off.....	42
2J. Servicing information	43
Warranty information and contacting customer services	43
Required information	43
Contact data	43
Fault finding.....	44



Document information

Version control

Date	Issue number	Description	Issued by
17 th September 2018	04	Installation and operating instructions and procedures for eikon e1s	Merrychef

Document purpose

The purpose of this guide is to give a brief introduction to the Merrychef eikon e1s oven. It is intended to get you started as well as to provide instructions on how to operate the system on a regular basis.

Related documents

This document forms one part of the overall Merrychef eikon e1s user manual. The complete manual is separated into three sections:



- Section 1: Safety Guide
- Section 2: Operations and Installation Guide
- Section 3: Service and Repair Guide

How to use this guide

This guide should be read prior to installing and using the appliance. It should also be used in conjunction with the Safety Guide (Section 1) and the Service and Repair Guide (Section 3).

Symbols and their meanings

Important information has been highlighted throughout this section using symbols and warning notices.

Symbol	Meaning
	Warnings of potential injuries. Heed all the warning notices that appear after this symbol to avoid potential injuries or death.
	See specified section or guide.
	Take note of this information.

Warning notices

Hazard level	Consequences	Likelihood
	Death / serious injury (irreversible)	Immediate risk
	Death / serious injury (irreversible)	Potential risk
	Minor injury (reversible)	Potential risk
	Damage to property	Potential risk



2A. Introduction to e1s

The Merrychef eikon e1s microwave combination oven offers you the flexibility of combination cooking with additional control over fan speed and microwave power.

Combination cooking enables high quality results to be achieved in a fraction of the time taken by conventional cooking, particularly when baking, browning, roasting and grilling dishes.

Once established, precise instructions for combination or convection cooking of selected items may be programmed into the oven's memory so that they can be repeated easily and accurately. Up to 1024 programmes can be stored and simply recalled.

The oven controls offer even greater flexibility by allowing multistage programming. This enables the exact conditions required for quality results to be set according to the food type. A single cooking programme can have up to six stages, each stage controlled with its own time, fan speed and microwave power settings.



Figure 2.1: e1s oven front view

Identifying your microwave combination oven

The following information is included at the rear of the oven on the name plate:

- Brand and name (Merrychef)
- Model range (e1s)
- Model number
- Serial number
- Supply voltage
- Maximum phase current
- Maximum supply power
- Output microwave power
- Output convected power
- Microwave frequency
- Manufacturer
- Manufacturing site
- Brand headquarters



Figure 2.2: e1s name plate



Appliance parts and their functions

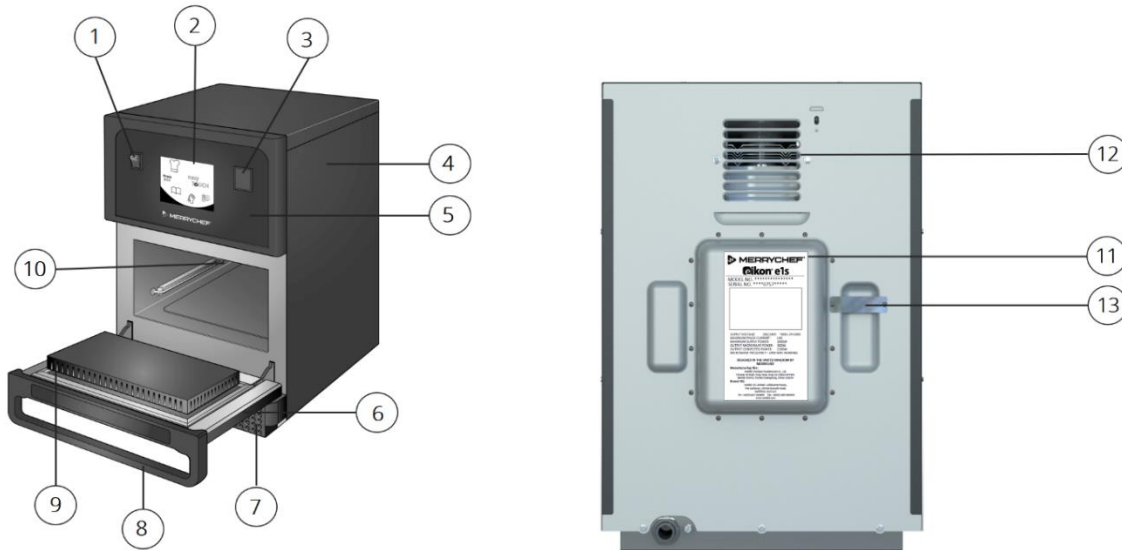

Figure 2.3: Appliance parts and their functions

- 1) **ON/OFF appliance switch** – Used to turn the microwave combination oven on and off. Turning this switch off does not isolate the appliance from the electricity supply.
- 2) **easyTouch® screen control panel** – When the appliance is switched on, the easyTouch® screen illuminates the user interface.
- 3) **USB port** – A USB socket located under the cover allows updates to programmes stored on the appliance.
- 4) **Protective cover** – The cover can only be removed with specific tools. It prevents live parts from being touched accidentally and prevents access to the moving fan. Always ensure the cover is securely in place.
- 5) **Operating panel** – Prevents live parts from being touched accidentally. Always ensure the panel is in place.
- 6) **Appliance door** – This is a precision-made energy barrier with three microwave safety interlocks. Always keep it clean and do not use it to support heavy objects.
- 7) **Air filter** – Situated at the lower front of the appliance, the air filter is part of the ventilation system. Keep it free of obstruction and clean it daily as described under *Section 2G: Cleaning procedures*.
- 8) **Door handle** – A rigid bar which is pulled downwards and away from the appliance to open it.
- 9) **Door seals** – Ensure a tight seal around the door. Always keep them clean and check regularly for signs of damage.
- 10) **Cavity** – Also known as the cooking chamber, the cavity is constructed from stainless steel and used for cooking products.
- 11) **Nameplate** – A plate on the rear of the oven that states the serial number, model type and electrical specifications.
- 12) **Air outlets** – On the rear and are used to cool internal components and allow steam from the cavity to escape. The air outlets must be kept free from obstruction and they will not allow microwave energy to escape into the environment.
- 13) **Steam pipe and cover** – A covered pipe from the cavity to the back of the oven to vent steam during cooking and prevent pressure build up.

Equipment and accessories supplied

The e1s microwave combination oven is supplied with the following equipment and accessories.



Cook plate

The cook plate sits inside the appliance and food is placed on top of it using suitable liners or baskets. It is removable for cleaning.

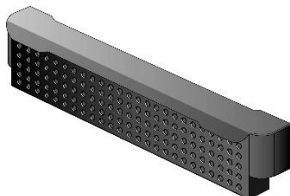

Air filter

The air filter situated at the lower front of the appliance is part of the ventilation system and should be kept clean and free of obstruction.

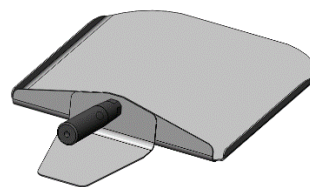

Paddle

The paddle is used to remove food from the oven.



There are a number of other optional Merrychef accessories that customers can purchase to use with the microwave combination oven. Contact Merrychef suppliers for more information.



2B. Installing the appliance



Users must read *Section 1: Safety Guide* before installing or using the microwave oven.

Unpacking

1. Cut the box banding straps and remove the lid.

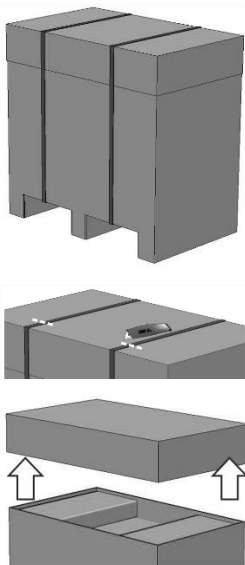

2. Remove the customer documentation and any product accessories:

- 1x air filter
- 1x cook plate
- 1x Safety Guide
- 1x Operations and Installation Guide

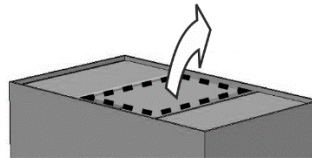

3. Remove the packaging to reveal your microwave combination oven.

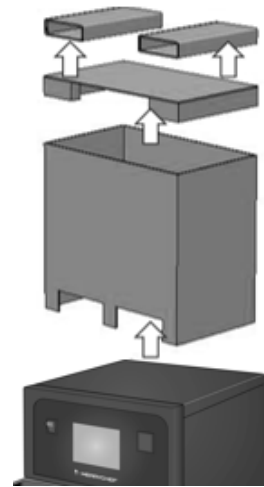

Inspect the appliance for damage before signing the delivery note. Record any damage on the delivery note and notify the carrier and manufacturer.



Never install or put into service a damaged appliance under any circumstances.

Taking the appliance off the pallet

1. Identify appropriate lifting points.



- Wear appropriate Personal Protective Equipment.
- **Do not lift the oven by the handle.**
- Risk of crushing from the appliance tipping over. Take precautions.

2. Lift the appliance from the packaging. The appliance is now ready for installation.

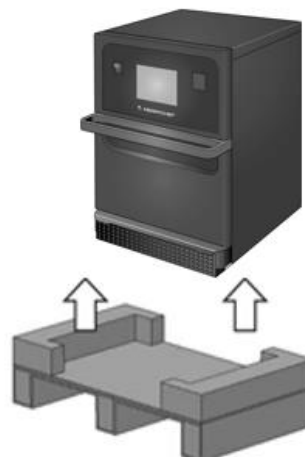

Installation location requirements

Minimum space required

Figure 2.4 shows the space required to install the appliance. It also shows the minimum horizontal distances from adjacent walls and surfaces. The safety clearance on the top must also always be complied with.

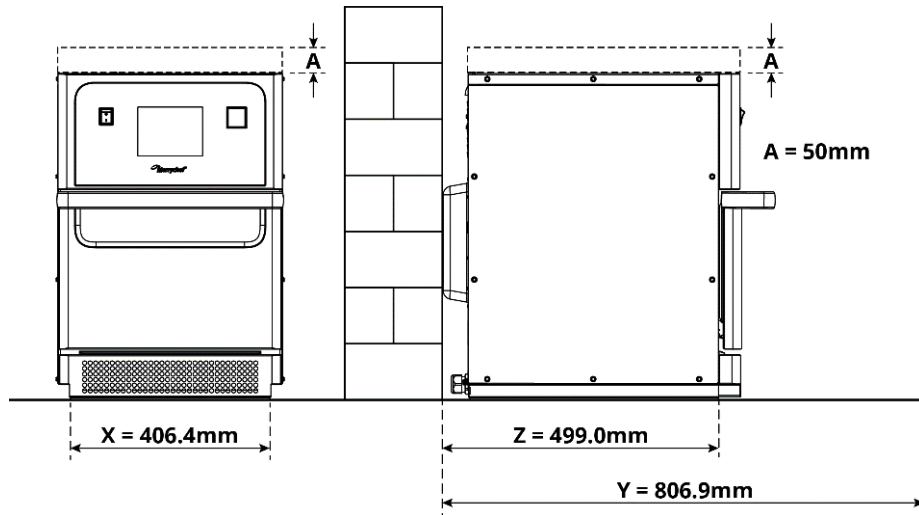

Figure 2.4: Minimum space requirements

- Safety clearance from the top (A) = 50mm (2")
- Depth requirement:
 - Width of appliance (X) = 406.4mm (16")
 - Total depth with door open (Y) = 806.9mm (31.8")
 - Counter depth (Z) = 499.0mm (19.6")
- Safety clearance on left-/right-hand side / at rear: 0mm

Actual space requirements

Far more room than the specified minimum space requirement is needed in front of the appliances to operate the microwave combination ovens safely, in particular to handle hot food safely. Larger wall gaps are generally recommended to provide access for servicing.

In the installation location, the following parts must not be covered, adjusted or blocked:

- Air vent on the rear of the appliance
- Air filter at the front of the appliance

Mounting the appliance on a work surface

The appliance can be mounted on a suitable work surface that can bear the weight.

Observe the following rules to ensure that the appliance is installed in a stable situation:

- The worktop must have a non-slip surface.
- The supporting surface must have the following properties:
 - The supporting surface must be flat and level.
 - The supporting surface must be able to bear the in-use weight of the appliance, plus the weight of the structure supporting the appliance as follows: 50Hz = 46kg / 101lbs and 60Hz = 45kg / 99lbs.



Electrical installation requirements

Safety rules

⚠ DANGER Observe the following rules to prevent hazards caused by faulty electrical connections:

- Only electricians qualified under the terms of EN 50110-1 and from an authorised service company are permitted to perform work on electrical equipment.
- The electrical supply must be connected in accordance with applicable local regulations of the professional associations and of the relevant power supply company.
- The case of the appliance must be grounded in a suitable manner and connected to an equipotential bonding system.
- If two microwave combination ovens are installed in a stacking kit, both cases of the appliances and the stacking kit itself must be grounded in a suitable manner and connected to an equipotential bonding system.
- Wear the personal protective equipment as specified in the *Safety Guide – Section 1F*.

Equipment provided by customer and electrical installation regulations

Table 2.1 shows what equipment must be provided by the customer and what regulations must be observed when connecting the appliance.

Equipment	Regulations
Fuse	Fuse protection and connection of the appliance must comply with local regulations and national installation requirements.
Equipotential bonding	The appliance must be incorporated in an equipotential bonding system. Equipotential bonding: electrical connection that ensures that the frames of electrical equipment and any external conductive components are at an equal (or practically equal) potential.
Residual-current device (RCD)	The installation regulations require protection by a residual-current device (RCD). Suitable residual-current devices meeting the relevant national regulations must be used. If the installation includes more than one appliance, one residual-current device must be provided for each appliance.
Disconnection device	An easily accessible all-pole disconnection device with a minimum contact separation of 3mm must be installed close to the appliance. The appliance must be connected via this disconnection device. The disconnection device is used to disconnect the appliance from the electrical supply for cleaning, repair and installation work.

Table 2.1: Electrical equipment and regulations

The requirements and specifications for e1s

Fitted frequency converter

- The appliance is fitted with one frequency converter (FC) and an EMC mains input filter.
- These devices may result in a leakage current of more than 3.5mA per FC drive.
- Use a suitable RCD for the rated voltage.



Properties of the residual-current device

The residual-current device (RCD) must have the following properties:

- Filter for filtering out RF currents.
- ‘Time delayed’ trip characteristic for RCD devices with trip threshold >30mA: prevents RCD being tripped by charging currents of capacitors and parasitic capacitances when appliance is switched on.
- ‘Leakage current protection, Type SI’ trip characteristic for RCD devices with trip threshold >30mA: insensitive to nuisance tripping.

Circuit Breakers

- Establishments with standard (Type ‘B’) circuit breakers are sensitive to ‘surges’ which occur on switching on freezers, refrigerators and other catering equipment, including microwave combination ovens. Because of this, a Type ‘D’ circuit breaker (designed specifically for this type of equipment) must be fitted. An individual, suitably rated circuit breaker should be fitted for each appliance installed.

Low impedance electrical supply

- This commercial combination microwave oven complies with EN 61000-3-11. However, when connecting sensitive equipment to the same supply as the appliance, the user should determine in consultation with the supply authority, if necessary, that a low impedance supply is used.

Electrical supply

- The e1s microwave combination oven is only available as a single-phase model and is designed to draw 13 amps maximum in all configurations, as shown in Table 2.2.

Illustration	Meaning
<p>UK / EU</p>	<p>Phase: Single</p> <p>16 A Breaker for 15/16 A plug configurations and be Time Delay, Motor Start Type (European Type D).</p> <p>UK 13 A models are fitted with a moulded plug to BS1363, fused at 13A. EU13 A models are fitted with a moulded plug to CEE 7/7 (Type F Schuko) rated at 16 A.</p> <p>ROW 13 A models are fitted with country specific 15/16 A plugs.</p> <p>Please contact your local Welbilt representative for further information.</p>
<p>Latin / South America</p>	
<p>China</p>	

Table 2.2: e1s electrical specifications

Equipotential bonding

- An equipotential bonding point is provided on the rear panel of the appliance for independent Earth (GND) connection.

2C. Getting started



Before turning on the oven, users must read the *Section 1G: Hazards and safety precautions when preparing appliance for use* in the Safety Guide.

Fitting the air filter

The air filter is fitted in position below the cavity door. It is a magnetic attachment.

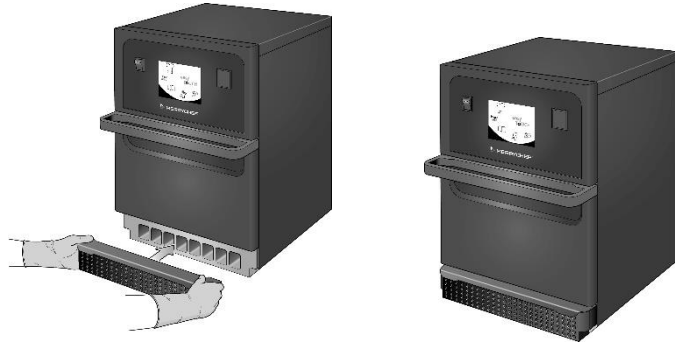

Inserting the cook plate

The cook plate is inserted in the cavity, simply by sliding it onto the shelf runners.

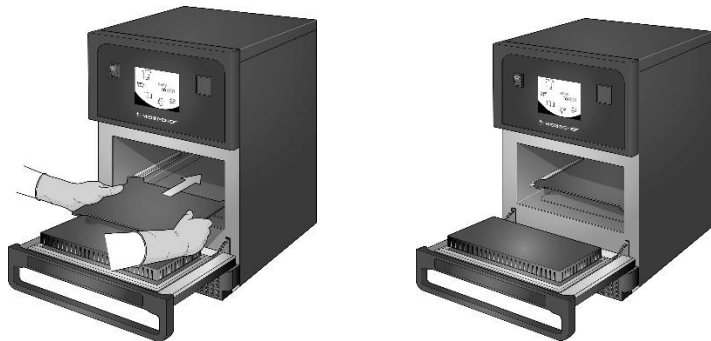

Turning the oven on and off

To start up the oven, ensure the appliance is clean and empty with just the cook plate inside it. Then switch the appliance on using the on/off switch at the front of the oven.



When the oven is switched on, the easyTouch® screen illuminates with the display briefly showing the serial number and appliance data. To keep the data on the screen, lightly tap the screen to freeze the display. Tap again to continue.



Settings on first usage

The system is preconfigured with all the required settings to start cooking immediately following installation. However, you may want to configure the following before using the oven.

- Date and time
- Alarms
- Temperature
- Oven time

Settings are changed by selecting the 'settings' screen which is accessible from the main menu.

However, the main menu is only displayed after the oven is pre-heated and therefore, if you want to change settings before or whilst the oven is heating, for example before first usage, do as follows:

- 1) Tap to hold the first screen upon switching on, which shows the serial number.
- 2) Press the hidden button at the top right-hand corner to load the password screen.

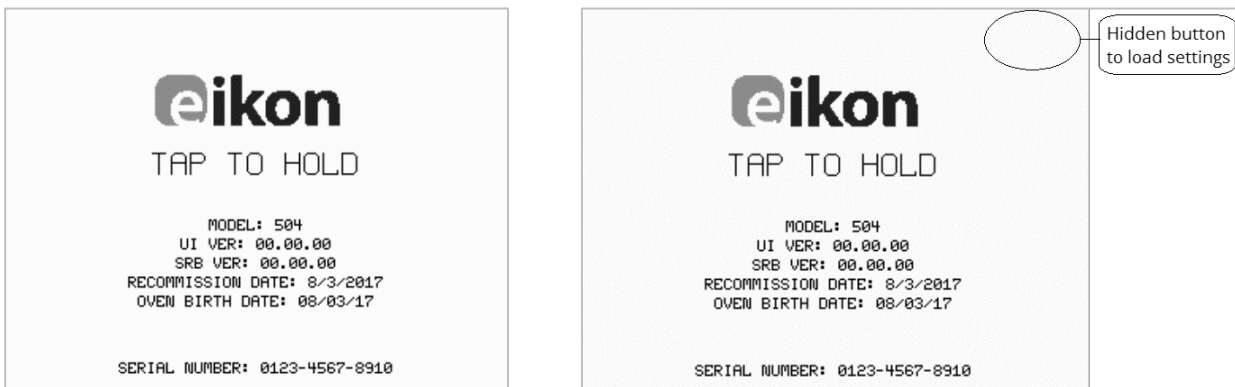

- 3) Enter the administration password. The default password is 'MANAGER'.
- 4) Select the required settings icon to make changes as required.

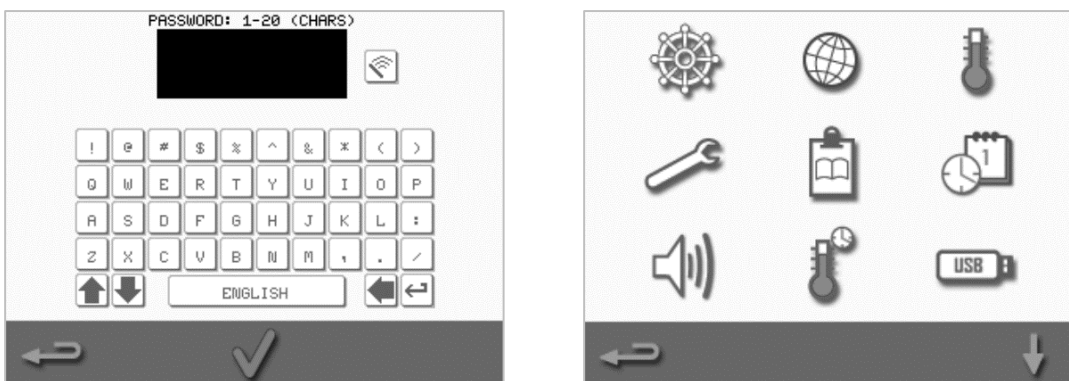

See *Section 2F: Changing settings* for instructions.



Selecting suitable utensils

You may want to ensure you have suitable utensils before using the oven. Only use utensils that are suitable for use in microwave combination ovens. Check the manufacturer's instructions and temperature rating to determine the suitability of individual containers or utensils.

Table 2.3 provides general guidelines:

Cooking utensils	Permitted	Notice
Heat resistant containers		
Toughened glass	YES	
Compatible vitreous ceramics	YES	Do not use items with metallic decoration
Earthenware (porcelain, crockery and china)	YES	
Metals, foils and plastics		
Metallic and foil trays and containers	NO	
Dual-ovenable plastic containers	YES	Use only containers approved by the manufacturer
Disposables		
Combustibles (paper, card, etc.)	YES	Use only combustibles approved by the manufacturer
Other utensils		
Tie tags	NO	
Cutlery	NO	Do not leave utensils in a food product while it is cooking
Temperature probes	NO	

Table 2.3: Suitable utensils

Preheating the oven

The oven will automatically preheat to the set temperature when it is switched on. However, if the appliance is set up with two or more preheating temperatures, a choice is displayed when the oven is switched on. Select the required temperature.



You may see a scroll arrow at the bottom of the screen which indicates that there are more temperature choices.

During preheating, the display shows the progress as the cavity heats up to the set temperature. To stop the cavity heating up, touch the red 'X' symbol at the bottom of the screen.

The appliance is ready to use when either the cookbook or main menu is displayed.

If the cookbook is displayed, press the Backspace button in the bottom left-hand corner of the screen to display the main menu.

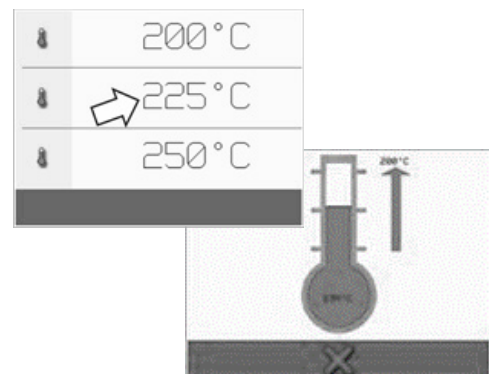

Understanding the main menu and keyboard



Main menu



Keyboard



The easyTouch® screen display, layout and icons shown herein are for guidance purposes only and are not intended to be an exact representation of those supplied with the appliance.

Button	Meaning	Function
Main menu		
	Development Mode	'Development Mode' enables multistage cooking profiles to be developed, then stored under a name and symbol for reuse.
	Press&Go	'Press&Go' allows quick access to use the cooking profiles that are already stored.
	Cookbook	'Cookbook' contains the cooking profiles stored in the memory of the appliance.
	Cleaning / Temp change	'Cleaning / Temp change' allows the cavity temperature to be changed and the appliance to be prepared for cleaning.
	Settings	'Settings' are used to control the appliance settings and functions and for service and maintenance purposes.
Keyboard		
	Keyboard screen	The 'keyboard screen' is used to enter password and to insert data for programmes.
	Clear screen	Select the 'clear screen' key to delete text from the keyboard screen.
	Keyboard	Use the 'keyboard' to type in text.
	Spacebar	Select the 'spacebar' key to insert a blank.
	Return	Select the 'return' key to start a new line.
	Keyboard scroll	Select the up/down arrows to scroll the keyboard screen.
	Enter / OK	Select the green tick to confirm settings and continue.
	Previous screen	Select the 'backspace' key to return to a previous screen.

Table 2.4: Main menu and keyboard items





Character length

- Use 1-20 characters in two lines max for names of cooking profiles, cooking profile groups and passwords.
- Use 1-54 characters in five lines max for stage instructions of individual cooking profiles.

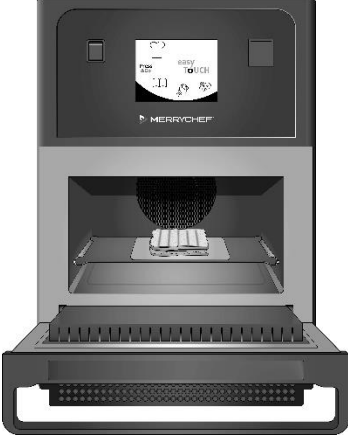

2D. Cooking procedures

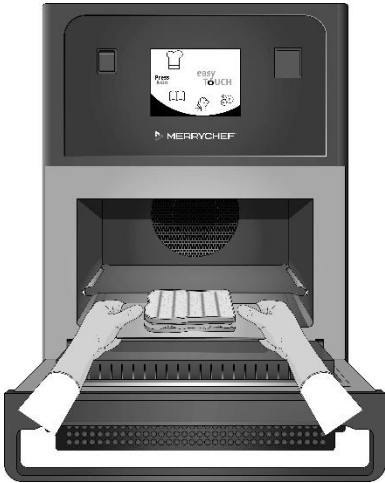
How to cook

 <p>1. On a preheated oven, select a cooking profile from the cookbook or enter a new cooking profile. <i>See Section 2E for instructions on how to enter a new cooking profile.</i></p>	 <p>2. Open the appliance door and place the prepared food on the cook plate. ⚠️ WARNING Hot surface <i>Ensure all packaging has been removed.</i></p>	 <p>3. Close the appliance door again. <i>The cooking process will automatically start if the programme was selected in step 1. Alternatively, the programme can be selected or changed at this stage.</i></p>
 <p>4. Wait for the cooking process to finish. An audible signal is given when the cooking process is finished. Follow the prompts displayed by the software. <i>Do not open the oven door while the food is cooking.</i></p>	 <p>5. Open the appliance door and take the food out. ⚠️ WARNING Hot surface <i>Do not remove cook plate unless cleaning.</i> <i>Never leave food in the oven, as it will continue cooking.</i></p>	 <p>6. Close the appliance door again after taking the food out. <i>The cooking programme is reset now and a new cooking profile can be selected to use the oven again.</i></p>

Using a cooking profile - quick serve mode

1. Select the 'cookbook' symbol  from the main menu screen and then select the All Menus option.



2. Use the scroll up/down arrows to find the cooking profile.

Note: If a picture has a red frame around it, this means the cavity temperature is set too high or too low for that cooking profile. The cavity temperature will need to be changed to use that option. See Changing cavity temperature.

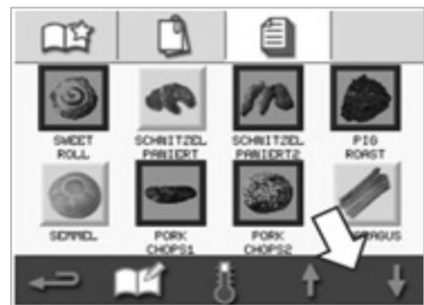

3. Select the required cooking profile to start cooking. For example: 'ITALIAN SUB x 1'.



4. Follow any instructions on the screen, if displayed, and press the green tick to start the cooking process.

Note: If food has not been placed in the oven, at this stage open the oven door and place it on the cook plate and then press the green tick.

⚠️WARNING Hot surfaces at the door and in the cavity.



5. The cooking time counts down for each stage. When the cooking profile ends, a red bar is displayed usually with an audible sound. Open the door or touch the red 'X' to return to the cooking profile.

Note:

- Opening the appliance door during cooking stops the cooking profile and displays a warning. Avoid opening the door during the cooking process.
- Closing the door, however, allows the user to continue or cancel the cooking profile.



Using a cooking profile - full serve mode

1. Select the 'cookbook' symbol  from the main menu screen and then select a group of cooking profiles, for example 'ITALIAN SUBS', to display the individual cooking profiles.

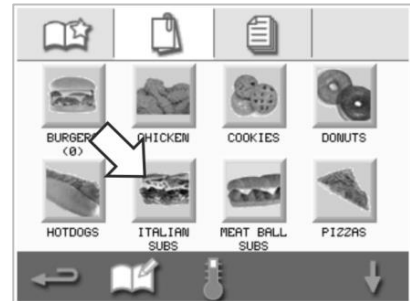

2. Select a cooking profile from the options available in the selected group, for example 'ITALIAN SUB x 2'.



3. Follow any instructions on the screen, if displayed. Press the green tick to start the cooking process.

Note: If the product has not been placed in the oven, at this stage open the oven door and place the food on the cook plate and then press the green tick to start cooking.

⚠WARNING Hot surfaces at the door and in the cavity.



4. The cooking time counts down for each programme stage. When the cooking profile ends, a red bar is displayed usually with an audible sound. Open the door or touch the red 'X' to return to the cooking profile.

⚠WARNING Hot surfaces at the door and in the cavity.

Note:

- To check the cavity temperature when cooking, lightly tap the temperature displayed. The cavity temperature is shown with an asterisk.
- Opening the appliance door during cooking stops the cooking profile and displays a warning. Avoid opening the door during the cooking process.
- Closing the door, however, allows the user to continue or cancel the cooking profile.

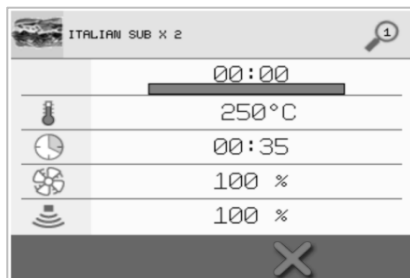
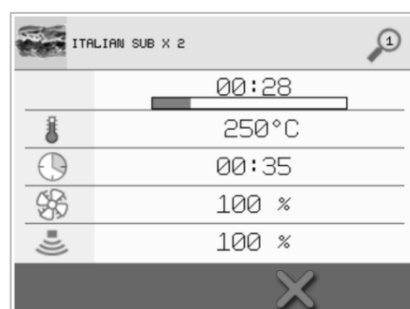

Choosing cooking profiles for Press&Go menu

1. Select 'Press&Go'  from the main menu screen, and then select the 'edit cookbook' symbol.

Two lists are displayed.

- The list on the left shows the cooking profiles that are part of the 'Press&Go' menu.
- The list on the right shows other cooking profiles that are available.

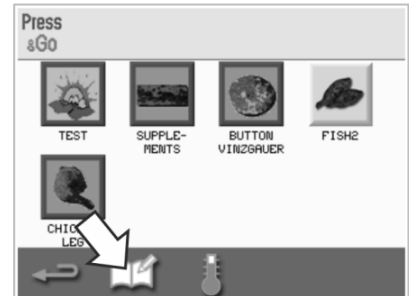

Both lists can be scrolled up or down using the blue arrows on the right of each list.

2. Select a cooking profile from the list on the left.
 - Choose whether to change its position within the list or to remove it into the list on the right.
 - To change the order of cooking profiles in the left list, use the blue up/down arrows in the middle.
 - To move a selected cooking profile to or from the 'Press&Go' menu, use the green/red arrows in the middle.
 - To make a cooking profile from the right list available in the 'Press&Go' menu, move it into the left list.

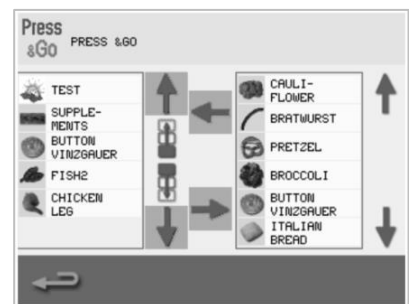

3. Select backspace to return to the 'Press&Go' menu screen when finished.

Running a cooking profile from the Press&Go menu

1. Select 'Press&Go'  from the main menu screen and then select the cooking profile required to cook.

Note: Follow any instructions on the screen, if displayed. If the product has not been placed in the oven, at this stage open the oven door and place the food on the cook plate and then press the green tick to start cooking.



2. The display shows the cooking time countdown. The timer bar turns red to indicate that the cooking cycle has finished.



Changing the cavity temperature

You may need to change the cavity temperature depending on the food you are cooking. If the cavity temperature is set to a value unsuitable for a cooking profile, it will need to be changed before that cooking profile can be used. Cooking profiles unsuitable for the set temperature are highlighted with a red border.

To change the cavity temperature:

1. Take note of the cavity temperature required for the cooking profile and then press the green tick to continue.

Note: You can find out the required temperature by selecting a cooking profile highlighted with red border.



2. Select the 'temperature' symbol in the selected cooking profile screen.

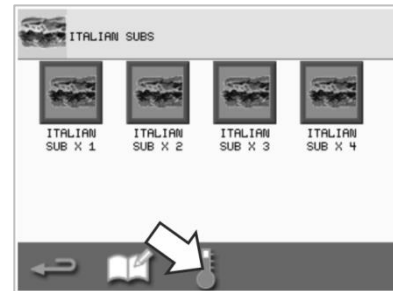

3. An asterisk next to the temperature value indicates the present cavity temperature. Select the required cavity temperature for the cooking profile.



2E. Cooking profiles

Creating a cooking profile

1. Enter development mode

Select the 'chef's hat' symbol from the main menu screen to enter development mode.



2. Set the microwave power

The temperature value displays the set preheating temperature. To change the temperature, select the 'temperature' symbol, and enter a value within the limits displayed.

Select the green tick to continue.

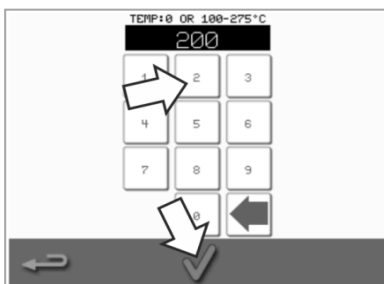
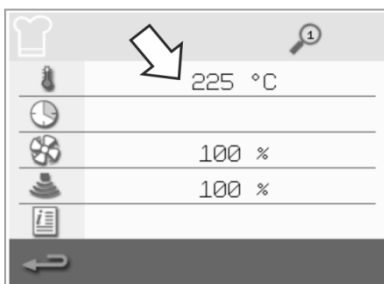

3. Set the cooking time

Select the 'clock' symbol and enter the cooking time for each stage up to a maximum of 10 minutes.

Example: Enter 110 = 1 minute and 10 seconds.

Select the green tick to save the inserted value.

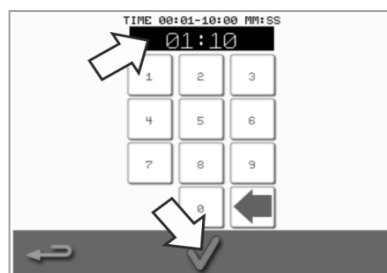
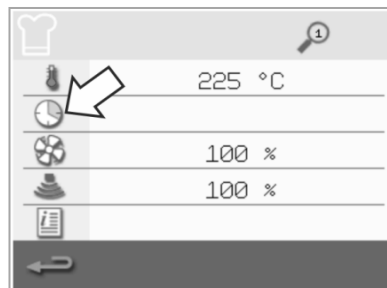

4. Set the microwave power

Select the 'microwave' symbol and set the microwave power (0 and 5-100%).

Select the green tick to save the inserted value.

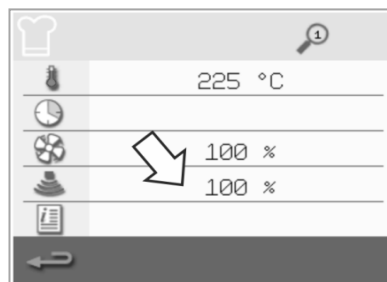

5. Set the fan speed

Select the 'fan' symbol and set the fan speed within the limits shown on the screen.

Select the green tick to save the inserted value.

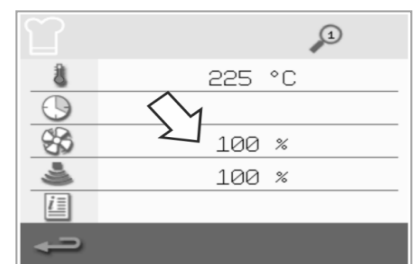

6. Enter instruction for a stage (optional)

Select the 'information' symbol to enter instruction for a stage.

Example: 'Stage 1 - place a food product into the cavity'.

Select the green tick to save the inserted instruction.

Select the right arrow with a 'plus' symbol at the bottom to add a new stage by repeating the steps above.

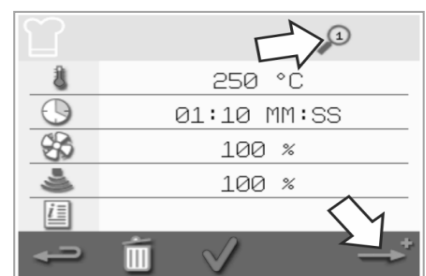

Note:

- Cooking profiles can have up to a maximum of six stages.
- The 'magnifier' symbol at the top indicates which stage is displayed.
- Select the left/right arrow at the bottom to shift between the stages.



Viewing and editing cooking profiles

1. Select the 'cookbook' symbol from the main menu screen.



2. Select the 'All menus' symbol from the cookbook screen.

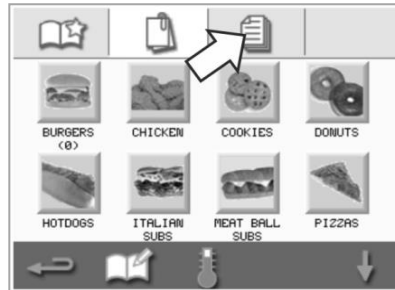

3. Select the 'edit cookbook' symbol.

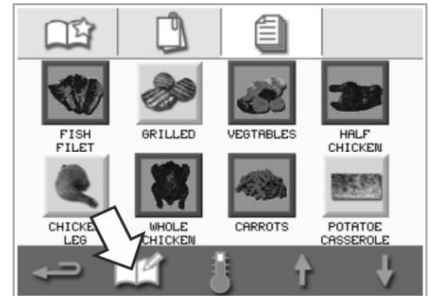

4. Use the up/down scroll arrows to find the cooking profile.

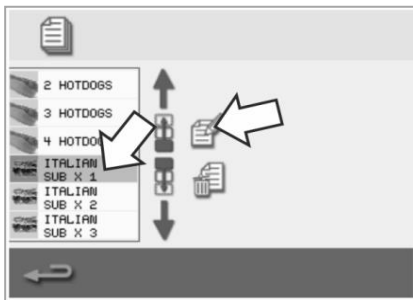

5. Select the 'view/edit cooking profile' symbol.

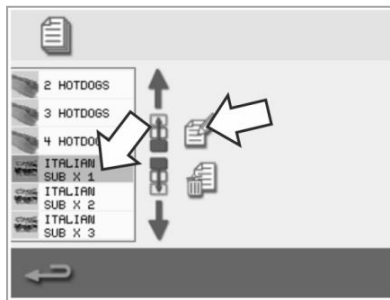

6. View or adjust the cooking profile as required.

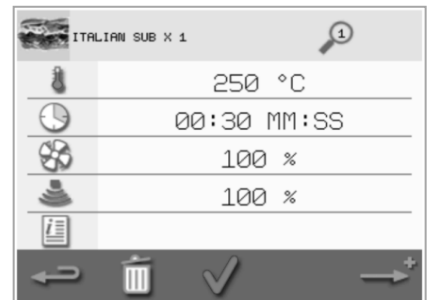

See *Creating Cooking Profile* for instructions on how to change cooking profile entries.

Moving a cooking profile in a group of cooking profiles

1. Select the 'cookbook' symbol from the main menu and select the group of cooking profile to move, e.g. 'ITALIAN SUBS'.

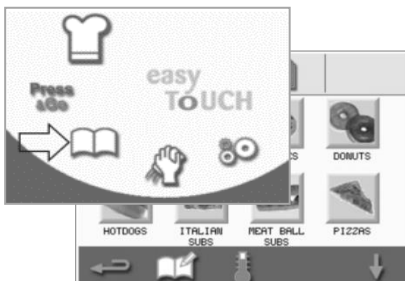

2. Select the 'edit cookbook' symbol in the selected cooking profile screen.

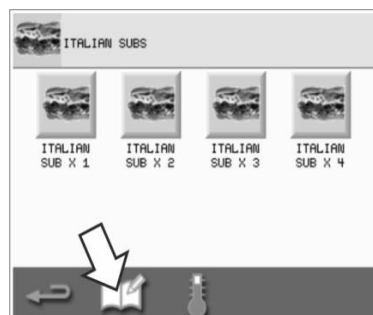

3. Select the cooking profile to move and use the smaller up/down arrows to move it within the group.

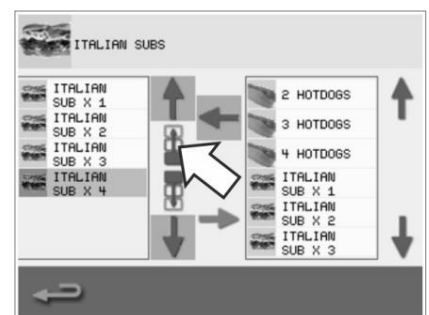

Moving a cooking profile in a list

1. Select the 'cookbook' symbol from the main menu screen and then select the 'edit cookbook' symbol in the cookbook screen.

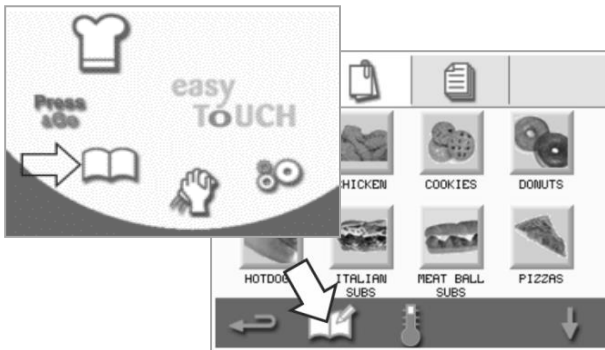

2. Use the big scroll arrows to locate cooking profile groups and then use the small arrows in the centre of the screen to move the selected cooking profile within the list. Use backspace to return to the cookbook screen.

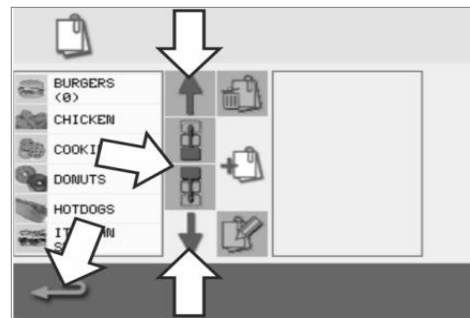

Adding a new cooking profile group

1. Select 'cookbook' from the main menu screen.
2. Select the 'edit cookbook' symbol from the cookbook screen.
3. Select the 'add a new cooking profile group' symbol.

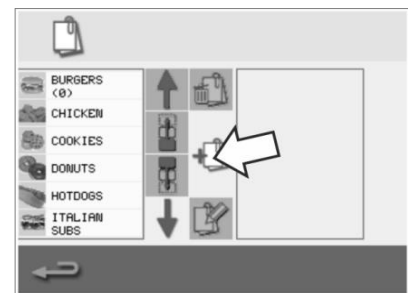
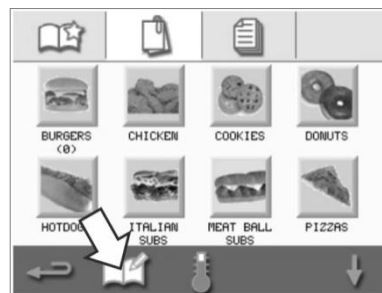

4. Select the 'camera' symbol to open a database of pictures.

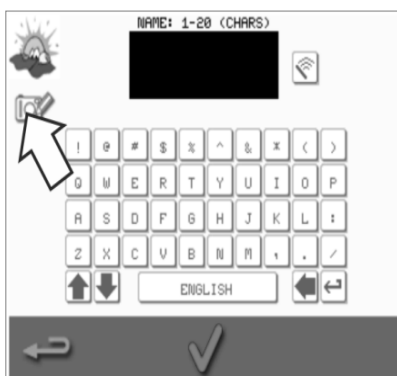

5. Select a picture for the cooking profile group. You can use the scroll arrows at the bottom of the screen for more pictures.

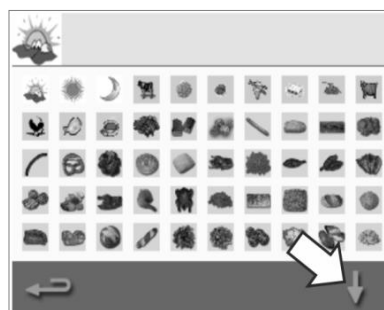

6. Enter a name for the new cooking profile group (max. 20 characters) and press the green tick to save it.

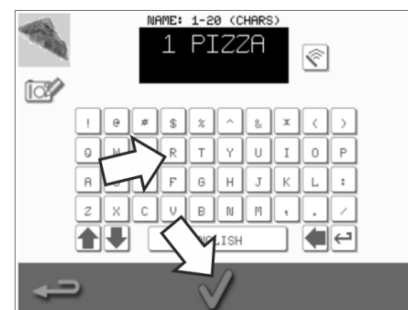

Adding a cooking profile to a group of cooking profiles

1. Select 'cookbook' from the main menu screen.
2. Select the cooking profile group you want to add to.
3. Select the 'edit cookbook' symbol in the cooking profile screen.

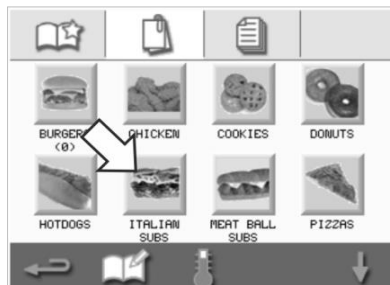

4. Use the up/down scroll arrows on the right to find and select the cooking profile you want to add.
5. Select the green 'left' arrow to add the selected cooking profile, which will now be listed on the left.

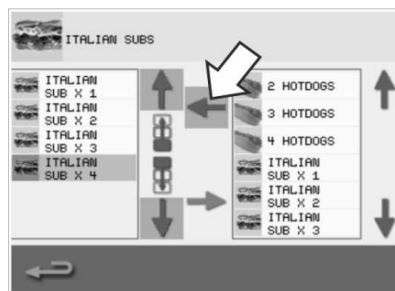
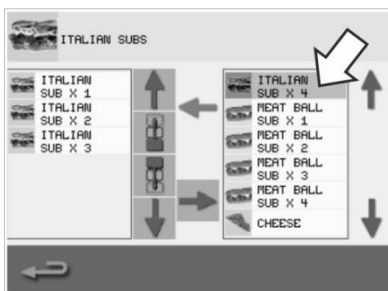

Deleting a cooking profile group

1. Select 'cookbook' from the main menu screen.
2. Select the cooking profile group to delete.
3. Select the 'edit cookbook' symbol.

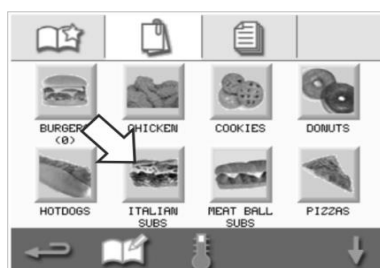

4. Select the 'delete cooking profile group' symbol.
5. Select the green tick to delete the cooking profile group.

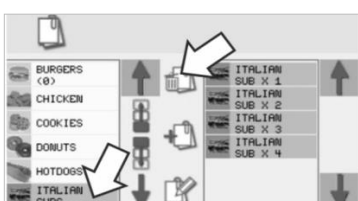

Editing a selected cooking profile group name

1. Select 'cookbook' from the main menu screen.



2. Select the 'edit cookbook' symbol from the cookbook screen.

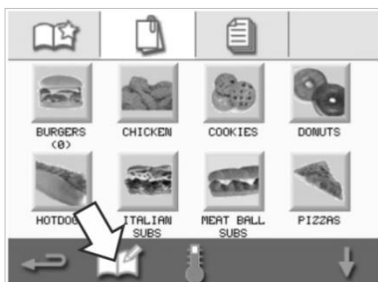

3. Select the cooking profile group that you want to edit.



4. Select the 'edit cooking profile group' symbol.

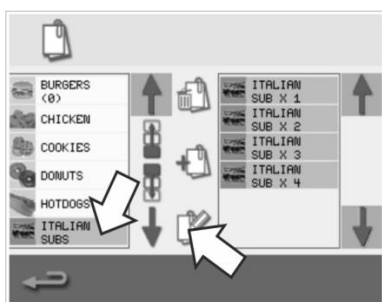

5. Enter the new name of the cooking profile group and select the green tick to continue.

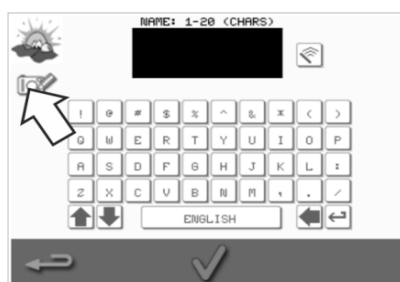

2F. Changing settings

Changing settings process

1. Select the 'settings'  symbol from the main menu screen.

Note: The main menu is displayed after the oven is pre-heated. If you want to change settings without pre-heating the oven, for example change settings before first usage, you should tap the first screen to hold it and then press the hidden key at the top right-hand corner to load the password screen, shown in step 2.

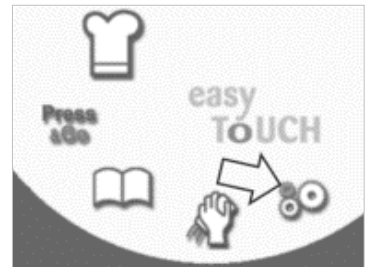

2. Enter your password and select the green tick to display the 'settings' options.

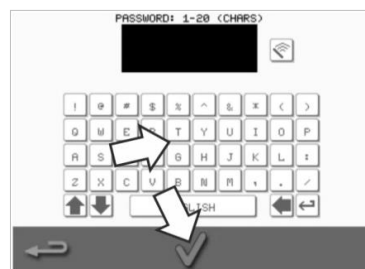

3. Make changes as required. Use the up/down scroll arrows at the bottom of the screen to display all functions of the 'settings' menu.

The 'settings' menu comprises the following functions:

- A. Operating mode / navigation settings
- B. Language options
- C. Cavity temperature settings and labels
- D. Service information and error logs
- E. Cooking profile counters
- F. Date and time settings
- G. Speaker and sound level settings
- H. Timer (Temperature / ON / OFF)
- J. USB programme downloads
- K. Temperature band settings
- L. Change settings / service access passwords
- M. Screen saver

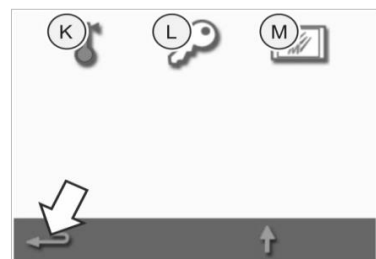
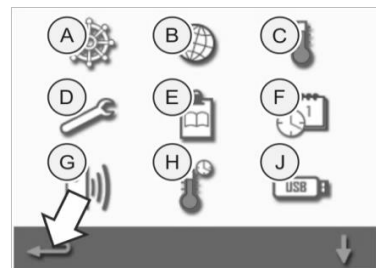

When finished with a setting, select backspace to return to the main settings menu to make other changes.

4. Press the backspace button to exit the 'settings' menu. A prompt appears to either 'SAVE' or 'DISCARD' any changed settings.



Operating mode / navigation settings

1. Select the 'operating mode/navigation' symbol from the settings menu.

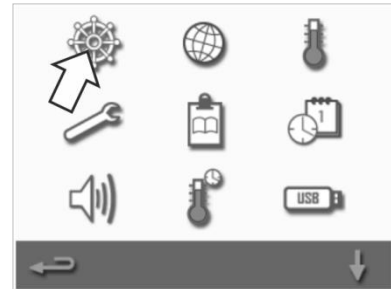

2. Select 'QUICK SERVE MODE' for cooking only.
Select 'FULL SERVE MODE' for creating cooking profiles.
Select 'MANUAL MODE' to manually cook only via the 'chef's hat' symbol on the main menu screen.
Select 'ENABLE SETTINGS' to display an 'unlock' symbol on the 'Quick Serve Mode' screen to allow access to the 'settings' menu.

Note: If a green tick is displayed, the corresponding function is active.

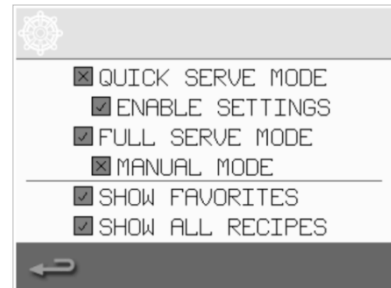

3. Select 'MAGNETRON ENERGY DELAY' to enable a magnetron warm up period for all cooking profiles.

Select 'ENERGY SAVING' to enable the hibernation mode when the oven is inactive.

Language settings

1. Select the 'globe' symbol from the settings menu



2. Select the checkbox(es) of the required language(s) from the list shown.



Cavity temperature settings and labels

1. Select the 'temperature' symbol from the settings menu.

The temperature screen is displayed if two or more cavity temperatures are set above the minimum. You can now:

- A) Change a temperature set
- B) Edit the existing temperature labels
- C) Add a new temperature
- D) Change the measurement unit

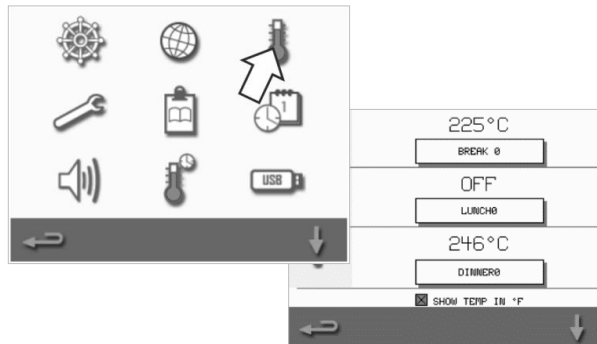

A) Change a temperature set

1. Select the temperature you want to change by tapping the value or the red temperature symbol next to it.
2. Edit the temperature as required using the keypad.
3. Select the tick to continue.

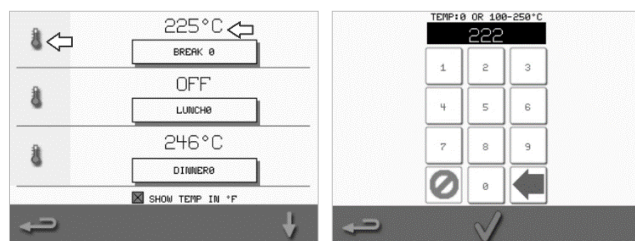

B) Edit temperature labels

1. Select the required label below the temperature.
2. Edit the label as required using the keypad.
3. Select the tick to continue.

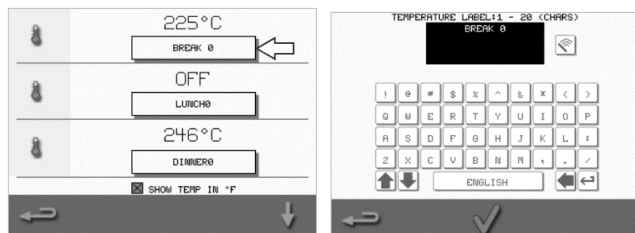

C) Add a new temperature

1. Select a disabled temperature option from the screen (scroll down using arrow if required).
2. Select the temperature area marked as 'disabled' or the red temperature symbol.
4. Enter a temperature value using the keypad and select the tick to continue.
5. Select the 'Optional Label' box to assign a label to the temperature and select the tick to continue.

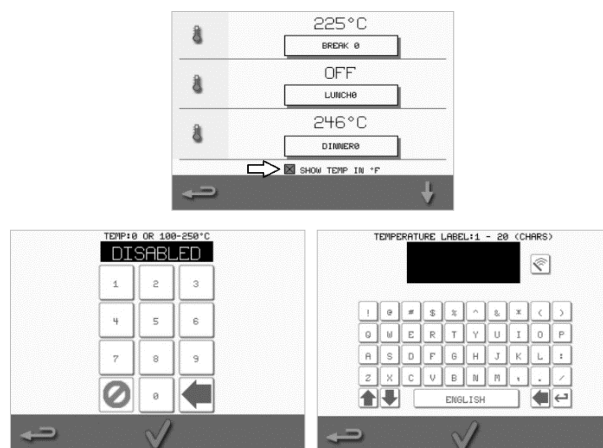

D) Change measurement unit

You can change the temperature measurement unit from Celsius to Fahrenheit and Fahrenheit to Celsius by simply selecting or deselecting the unit checkbox.

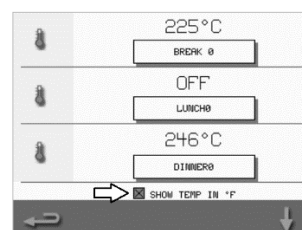

Service information and error logs

The service information and error log function is required for servicing and repairing the system and therefore covered in *Section 3: Service and Repair Guide*.



Cooking profile counters

1. Select the 'clipboard' symbol to display a listing of cooking profile counters.



2. The recipe counts are listed on the right of the screen. Use the up/down arrows at the bottom of the screen to scroll to the required recipe.

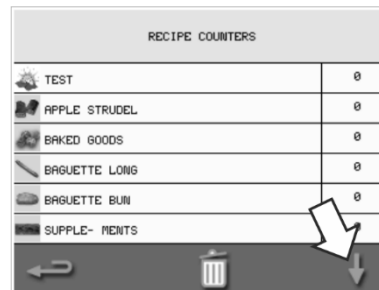

Adding recipes

Recipes can be uploaded from a USB stick. See *USB programme downloads*.

Removing recipes

You can remove a recipe by selecting it and then selecting the bin symbol.



Setting the date and time

1. Select the 'clock/date' symbol from the settings menu to display the setting options.

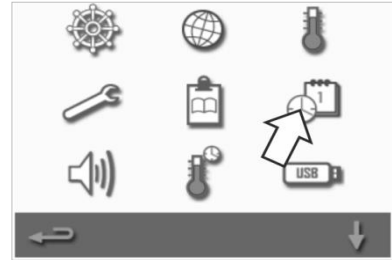

Change the date:

2. Select 'MONTH', enter the correct month on the keypad and select OK.
3. Select 'DAY', enter the correct day on the keypad and select OK.
4. Select 'YEAR', enter the correct last two digits of the year on the keypad and select OK.
To display the month first, followed by the day and year, select the 'MM-DD-YY' checkbox.
A correct date supports servicing as the error logs are recorded using these date settings.

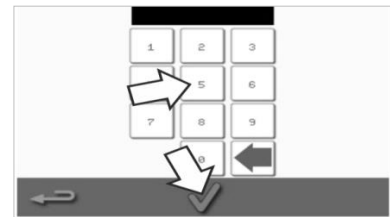
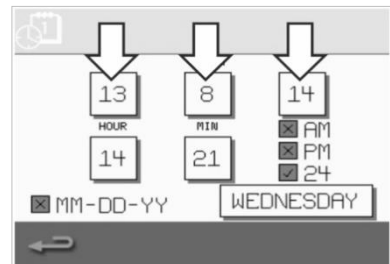

Change the time:

5. Select 'HOUR', enter the correct hour on the keypad and select OK.
6. Select 'MIN', enter the correct minutes on the keypad and select OK.

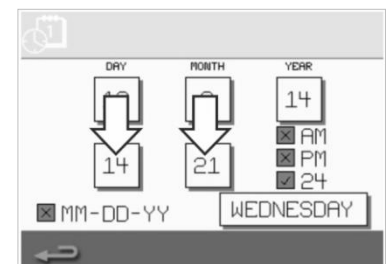

7. Select the day name.

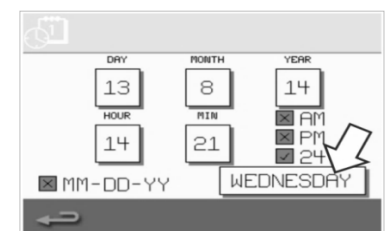

Sound settings

1. Select the 'speaker' symbol to access the volume, tone and further sound settings.

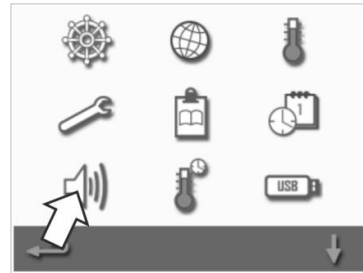

2. Make changes as required:

- a) Select the 'speaker' symbol to adjust the volume level suitable for the environment from none (OFF) to the loudest (100%).
- b) Select the 'music note' symbol to set LOW, MED or HIGH tone.
- c) Select the 'keypad' symbol to switch the sound ON or OFF when the touchscreen is pressed.

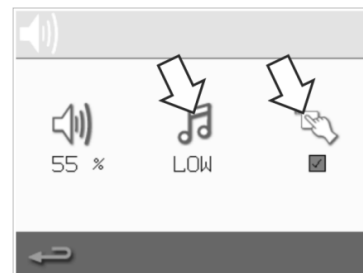

Temperature timer setting

1. Select the 'thermometer / timer' symbol from the settings menu.

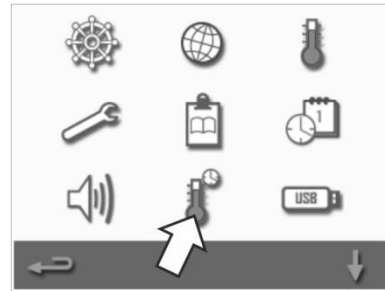

2. Select the 'timer enabled' checkbox (green tick).
3. Select a weekday using the up/down arrows at the bottom of the screen.
4. Select an empty 'time' box (maximum of five per day) or clear an existing 'time' box using the 'wipe' symbol next to it.

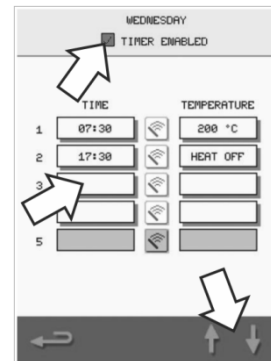

5. Enter the start time on the keypad. Press the green tick to continue.

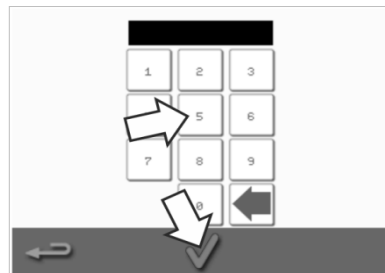

6. Select an empty 'temperature' box opposite the respective 'time' box or clear the required 'temperature' box using the 'wipe' symbol next to it.

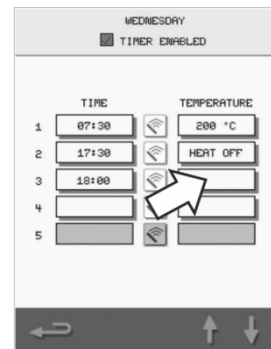

7. Enter the cavity temperature required on the keypad.

Alternatively:

- Select zero to turn the heat OFF.
- Select the red circle symbol to switch OFF the appliance.

Press the green tick to continue.

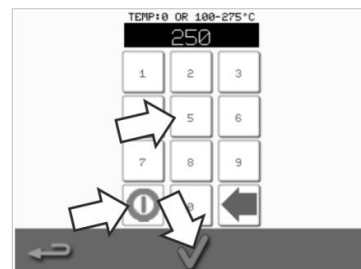

USB programme downloads

1. Switch the appliance OFF and open the cover to the USB port on the control panel at the.

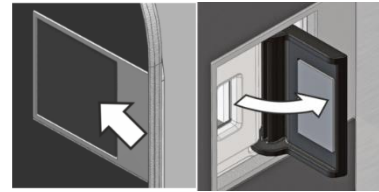

2. Plug in the USB memory stick and switch on the oven.

Note: If the USB memory stick is too large, use a standard commercial adapter cable.

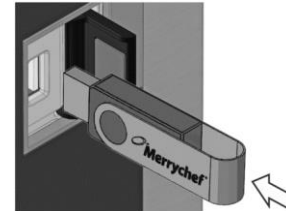

3. Select the 'USB' symbol from the settings menu.

Note: Check that the memory stick has the correct number/code for the programmes you want to load into the memory (one '.cbr' file and 'autoupdate').

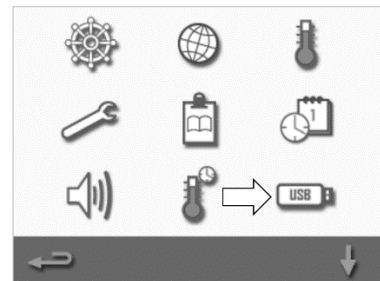

4. Select the type of file you are downloading (firmware or recipes). The files will now automatically download from the USB memory stick showing the progress and confirmation screens for the update.



IMPORTANT: Downloading from a USB memory stick will clear all the existing programmes in the memory of the appliance.



The USB cover protects the USB port so that no water vapour can get into the control electronics. During cooking and cleaning, there must not be a USB memory stick inserted and the USB port must be closed by the cover.



Temperature band setting

1. Select the 'temperature band' symbol.



2. Select the required temperature band checkbox, shown by a green tick.

Note: Generally, the lowest practical 'Temp Band' should be chosen. If the set cavity temperature falls by more than the selected temperature band value, the ready-to-cook mode and the temperature band are deactivated until the cavity reaches the preset preheat temperature.

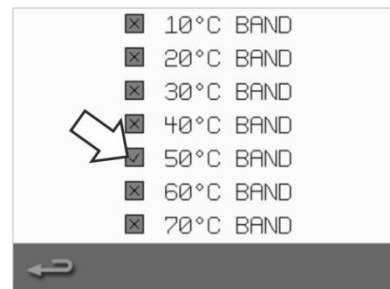

Change setting / service access password

1. Select the 'key' symbol to change the passwords of the appliance.

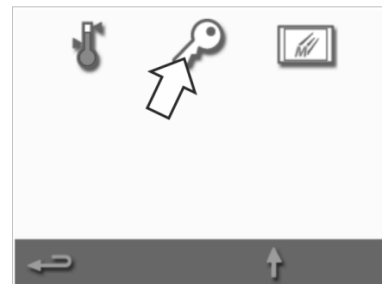

2. Select the appliance 'settings' or 'service' symbol.

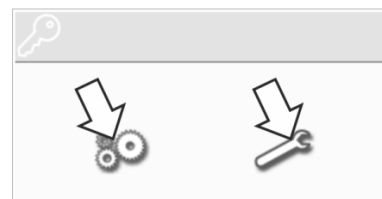

3. Enter the existing password and press the green tick to confirm.
4. Enter a new password and press the green tick.
5. Confirm the new password and press the green tick again.

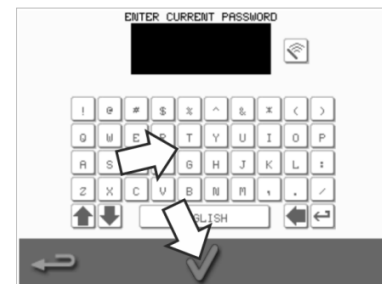

Set screen saver

1. Select the 'ENABLED' checkbox to switch the screen saver ON or OFF and select the 'time' box below it.

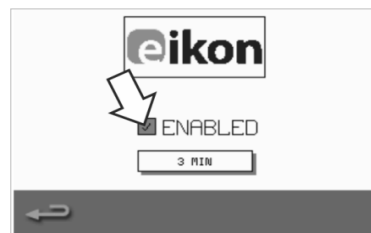

2. Enter a time delay on the keypad from 1 to 60 minutes before the screen saver starts. Press the green tick to confirm.



3. An active screen saver will mask the screen showing a moving image. To use the touchscreen, tap the screen to deactivate the screen saver.



2G. Cool-down procedures



The microwave combination oven must be cooled down properly before cleaning, servicing or repairing. Users must read the *Safety Guide - Section 1J: Hazards and safety precautions during servicing and repair* and *Section 1K: Hazards and safety precautions when taking the appliance out of service*.

To cool down the appliance:

1. Select the thermometer symbol from the cookbook or the cleaning symbol from the main menu (full serve mode).

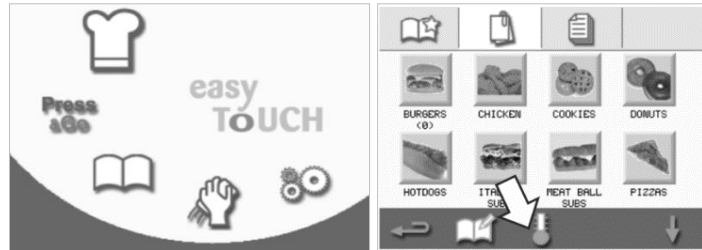

2. In the temperature screen, select the blue thermometer symbol to disable heating and start the cooling cycle.



3. The cooling progress is displayed and takes approximately 20 minutes. To reduce the cool-down time, leave the appliance door open slightly during the cooling process.

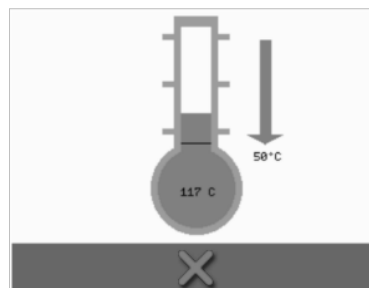

4. Once the cooling process is complete, you will see a 'Clean Cavity' screen. The oven is now ready for cleaning or servicing and repairing.

Cleaning instructions is provided in *Section 2H: Cleaning procedures*.

Service and repairing is covered in *Section 3: Service and Repair Guide*.



2H. Cleaning procedures

Daily cleaning tasks

What must be cleaned?	Procedure	Cleaning chemicals
Cavity	Clean by hand with a soft cloth or paper towel	Cleaning and protective chemicals approved by the manufacturer
Outside of appliance	Clean by hand with a soft cloth	Common household stainless-steel cleaner or hard surface cleaner
Containers, baking sheets, shelf grills and other accessories used for cooking	Clean by hand with a soft non-abrasive sponge and rinse off after with water	Common household detergent
Air filter	Wipe clean or wash in soapy water	Common household detergent

Table 2.5: Cleaning tasks

Cleaning items

Use solely the cleaning chemicals specified in Table 2.6 to clean the microwave combination oven and its accessories.







Product		Use
Merrychef Cleaner		Cleaning the cavity and appliance door
Merrychef Protector		Protecting the cavity and appliance door
Common household stainless-steel cleaner or hard surface cleaner		Caring for the external surfaces of the microwave combination oven
Common household detergent: mild on skin, alkali-free, pH-neutral and odourless		Cleaning components and accessories and fittings according to relevant instructions
Protective rubber gloves		To protect hands from cleaning agents
Non-abrasive nylon scrub pad		For all surface and door cleaning
Cleaning towel and cloths		For all surface and door cleaning
Eye protection		To protect eyes from cleaning agents
Dust mask (optional)		To protect from inhaling cleaning agents

Table 2.6: Cleaning items

Cleaning instructions



- Ensure the oven has been cooled down as per the instructions in *Section 2G: Cool-down procedures*.
- Users must read *Section 1I: Hazards and safety precautions during cleaning* in the Safety Guide.
- Wear protective glasses and protective rubber gloves during cleaning.

CAUTION

- Never use sharp implements or harsh abrasives on any part of the appliance.
- Do not use caustic cleaners on any part of the appliance or cavity.
- Do not scrub the roof (jet plate) or door seal.
- Do not use metallic scourers on any part of the appliance at any time.
- Do not spray cleaning product directly into the cavity.
- Do not use the appliance without a clean air filter in place.

Pre-cleaning checklist

- The appliance has been cooled down correctly
- No food has been left in the cavity.
- All containers, baking sheets, shelf grills and any other accessories have been removed from the cavity.

Cleaning process

There are several stages in the cleaning process:

Stage 1: Clean and dry the oven and oven parts

Stage 2: Apply oven protector (optional)

Stage 3: Clean the air filter and external surfaces

Stage 4: Cure the protective chemical (if oven protector applied)



Stage 1: Clean and dry the oven and oven parts

1. In a cooled-down oven (see section 2G), open the door and remove the cook plate and any other cooking accessories.

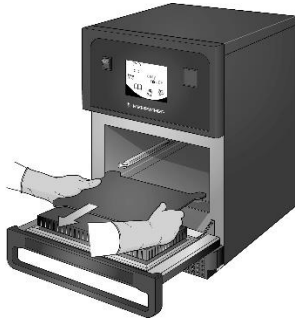

2. Wash all removed oven parts in warm soapy water. Wash off using a clean cloth and plenty of warm water.

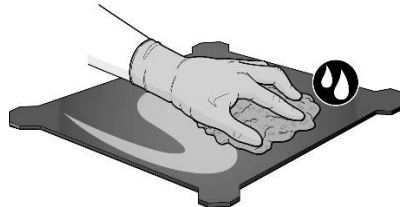

3. Use a dry clean brush to remove any food particles from between the cavity floor and the inside of the front door.

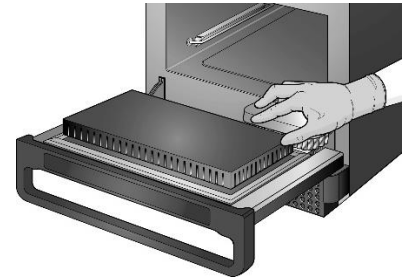

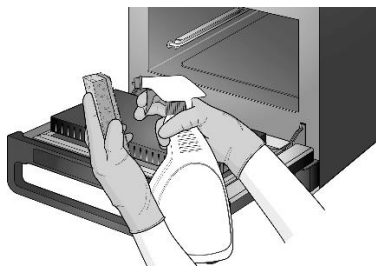

4. Spray Merrychef approved cleaner onto a sponge and clean all internal surfaces **except the cavity roof (jet plate) and door seal**.

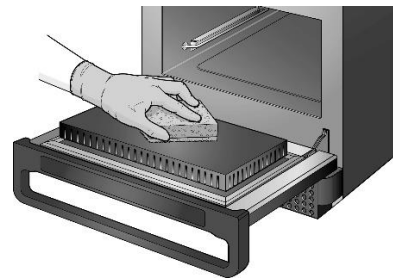

 Do not spray directly into the cavity.

5. For difficult areas, leave to soak for 10 minutes with the appliance door open. Use a non-abrasive nylon scrub.



 Do not scrub.

6. Wash off all surfaces using a wet clean cloth. The cavity roof and door seal can be wiped clean with a wet clean cloth as well.

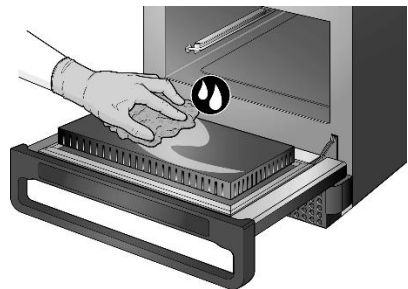

7. Dry all surfaces and oven parts using a clean cloth or paper towel.

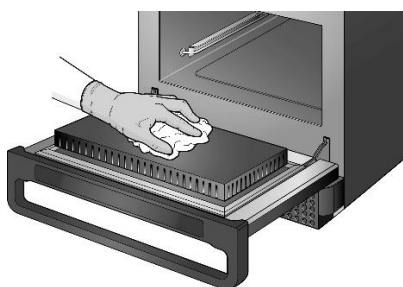

8. Press the tick on the clean cavity screen to continue.



9. A prompt will appear to apply the oven protector (optional).

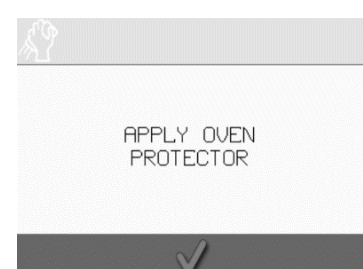

Stage 2: Apply oven protector (optional)

1. Spray Merrychef protector or a Merrychef approved protector onto a clean sponge.

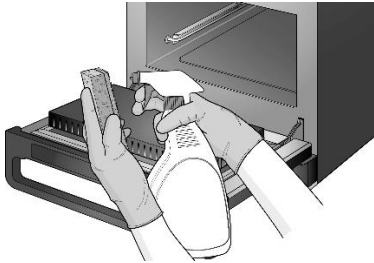

2. Spread the protective chemical lightly onto all internal surfaces, avoiding the roof (jet plate) and door seal.

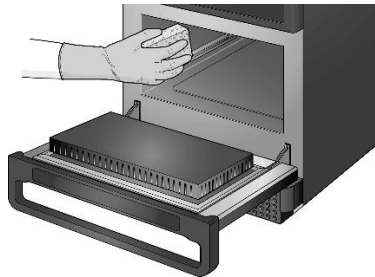

3. Replace the cleaned and dried cook plate.

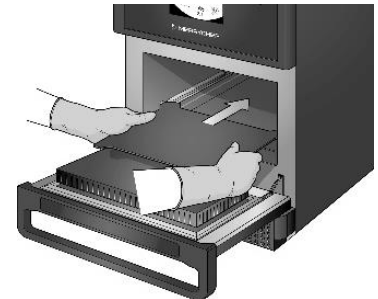

4. Press the tick on the apply oven protector screen to continue.



5. A prompt appears to clean the air filter.



Stage 3: Clean the air filter and external surfaces

1. Remove the air filter by gently pulling it.

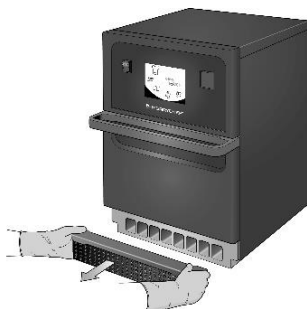

2. Wipe the air filter clean or wash in soapy water.

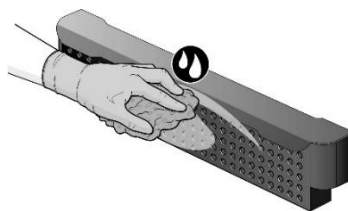

3. Dry and replace the air filter.

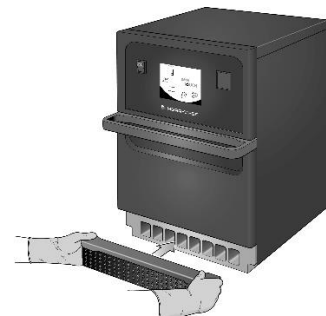

4. Press the green tick to confirm cleaning of the air filter.

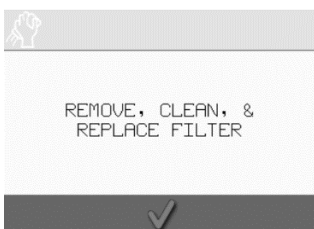

5. The oven switches OFF automatically.

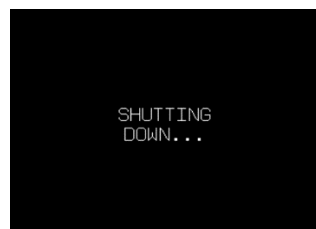

6. Wipe the external surfaces of the oven with a damp cloth.



Stage 4: Cure protective chemical (if oven protector applied)

1. Switch ON the appliance using the on/off button.



2. Preheat the cavity. Once reaching the preset operating temperature it will take about 30 minutes to cure the protective chemical.

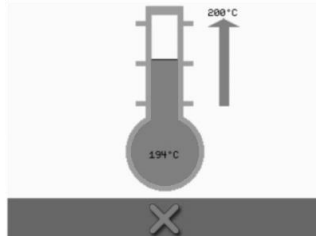

3. The protective chemical turns light brown when cured and the oven is ready to be used again.



2I. End of day operations

Turning the oven off

1.



Switch off the microwave combination oven using the on/off switch at the front of the appliance.

2.



Leave the appliance door ajar to let moisture escape.

Note: Switch off the power on site, before prolonged breaks in use.



2J. Servicing information

Warranty information and contacting customer services

In order to be able to claim under the warranty for the microwave combination oven, the appliance must be installed in accordance with the instructions in the Operations and Installation Guide by a qualified service engineer from an authorised service company.

The warranty does not cover damage resulting from improper setup, installation, use, cleaning, use of cleaning chemicals, servicing or repair.

Required information

Please have the following appliance data to hand when contacting Welbilt customer service:

- Serial number of your appliance
- Part number if you are calling about a specific part of the appliance

This serial number of the appliance can be found at the rear of the oven on the nameplate, as shown in Figure 2.5.



Figure 2.5: e1s rear view with nameplate

Contact data

Welbilt UK Ltd.
Ashbourne House, The Guildway,
Old Portsmouth Road
Guildford, GU3 1LR
United Kingdom
Tel: +44 (0) 1483 464900
Fax: +44 (0) 1483 464905
Website: www.merrychef.com and www.welbilt.com



For further information on servicing, maintenance and repair, please refer to *Section 3: Service and Repair Guide*.



Fault finding

Although every effort is made to ensure your oven will continue to perform to a high standard, please check Table 2.7 to see if the problem can be easily resolved before contacting your service agent.

Problem	Possible cause	Remedy
The appliance does not work and the display screen is blank	<ul style="list-style-type: none"> The appliance has no power 	<ul style="list-style-type: none"> Check if there is a power cut Check if the isolator switch is ON or the appliance is plugged in correctly Check if the appliance switch is ON
Some screen controls do not work	<ul style="list-style-type: none"> Unauthorised access 	<ul style="list-style-type: none"> Contact an authorised user
Display shows a warning message	<ul style="list-style-type: none"> Details are shown on screen 	<ul style="list-style-type: none"> Follow the instructions displayed
The appliance does not cook the food correctly	<ul style="list-style-type: none"> Appliance is not clean Food not at correct temperature Modified or wrong programme selected Food wrapped Food removed early 	<ul style="list-style-type: none"> Clean the appliance Use the correct cooking programme Unwrap food Check if all the cooking stages have been followed correctly
The appliance does not finish cooking	<ul style="list-style-type: none"> Warning message displayed The appliance door is open No air filter or incorrectly fitted Overheating of the appliance 	<ul style="list-style-type: none"> Close the appliance door Refit the air filter Allow the appliance to cool down Check and remove any restrictions around the air vents
Display shows an error code	<ul style="list-style-type: none"> Malfunction of the appliance 	<ul style="list-style-type: none"> Note the error code and contact your service agent

Table 2.7: Fault finding guidelines



For further information on servicing, maintenance and repair, please refer to *Section 3: Service and Repair Guide*.





eikon[®] e1s

Microwave Combination Oven

Welbilt is one of the world's largest manufacturers and suppliers of professional gastronomic appliances. We supply our customers with energy-saving, reliable and market-leading technologies from a single source.

If you want to find out more about Welbilt and its company brands, please visit us at www.welbilt.com